



**Bartscher
PRO II 40T
A190148**

**Bartscher
PRO II 60T
A190167**

**Bartscher
PRO II 100T
A190198**

ENGLISH

Table of contents

1. Safety 24
1.1 Key to symbols 24
1.2 Safety instructions 25
1.3 Proper use 29

2. General information 30
2.1 Liability and Warrantees 30
2.2 Copyright protection 30
2.3 Declaration of conformity 30

3. Transport, packaging and storage..... 31
3.1 Delivery check 31
3.2 Packaging..... 31
3.3 Storage..... 31

4. Technical data 32
4.1 Overview of parts 32
4.2 Technical specification 34

5. Installation and operation..... 35
5.1 Installation 35
5.2 Operation..... 36

6. Cleaning and descaling 39

7. Possible Malfunctions 43

8. Waste disposal 44

Bartscher GmbH
Franz-Kleine-Str. 28
33154 Salzkotten
Germany

phone: +49 (0) 5258 971-0
fax: +49 (0) 5258 971-120



Read this instruction manual before using and keep them available at all times!

This instruction manual contains information about the installation, operation and maintenance of the device and should be consulted as an important source of information and reference guide.

Awareness of the safety instructions and instructions for use in this manual will ensure the safe and correct use of the device.

In addition to the information given here, you should comply with any local Health and safety Controls and generally applicable safety regulations.

The instruction manual forms part of the product and should be kept near the device and easily accessible for anyone carrying out the installation, servicing, maintenance or cleaning.

Please keep these instructions and give them to future owners of the device.

1. Safety

This device is designed in accordance with the presently applicable technological standards. However, the device can pose a danger if handled improperly and inappropriately.

All persons using the device must follow the recommendations and instructions in this instruction manual.

1.1 Key to symbols

In this manual, symbols are used to highlight important safety instructions and any advice relating to the device. The instructions should be followed very carefully to avoid any risk of accident, personal injury or material damage.



WARNING!

This symbol highlights hazards which could lead to injury.



WARNING!

This symbol highlights dangerous situations which could lead to injury or death.



HOT SURFACE!

This symbol is a warning that the device surface is hot when in use. Ignoring this warning may result in burns!



HOT STEAM!

This symbol indicates that during the operation the hot steam escapes from the device. Risk of scalding if safety instructions are not observed!



CAUTION!

This symbol highlights dangerous situations which could lead to light injuries, or damage, malfunction, and/or destruction of the device.



NOTE!

This symbol highlights recommendations and information aimed for effective and trouble-free device operation.

1.2 Safety instructions

- The device can be used by children **8 years and up**, as well as by people with disabilities and those with limited experience/knowledge as long as they are under supervision or have been instructed on proper use of the device and its possible dangers. **Children should not play with the device. Cleaning and maintenance cannot be performed by children** younger than 8 years old and must be done under supervision. **Children under the age of 8 years old** must be kept away from the device and its power cord.
- **Never** leave the device unattended when in use.
- Only use the device indoors.

- The device must be operated in correct and safe technical condition only. In case of operational problems disconnect the device from the power supply (pull the plug from the socket) and contact the service company.
- Prevent access of children to the package materials like plastic bags and foamed polystyrene elements. **Suffocation hazard!**
- Only a qualified technician and using original spare parts and accessories should carry out repairs and maintenance of the device. **Do not attempt to repair the device yourself.**
- Do not use any accessory or spare parts that have not been recommended by the manufacturer. These can be dangerous for the user or lead to damages of the device or personal injury, and further, the warranty expires.
- To prevent hazards and to ensure optimum efficiency, no modifications or alterations to the device that are not explicitly approved by the manufacturer may be undertaken.



DANGER! Electric shock hazard!

To avoid the hazard results please follow the safety instructions below.

- Never allow the power cable to come into contact with heat sources or sharp edges. The power cable should not hang over the side of the working surface. Ensure that no one can step on or trip over the cable.
- The power cable must not be folded, bent or tangled, and must always remain fully unrolled. Never place the device or other objects on the power cable.

- Do not cover the cable. Keep away the cable from operating range.
- Check the power cord regularly for damage. Do not use the device if the power cord is damaged. If this cable is damaged, it must be replaced by customer service or a qualified electrician in order to avoid dangers.
- The supply cable must be disconnected from the socket only by pulling the plug.
- Never carry or lift the device by the supply cable.
- In any case do not open the device housing. In case of electrical or mechanical modifications the **electric shock hazard** will occur.
- Do not use any acid agents and make sure no water ingresses the device.
- **Never** operate the device with moist hands or standing on wet floor.
- Remove the plug from its socket:
 - when the device is not used,
 - in case of anomalies during operation,
 - before cleaning.



HOT SURFACE! Risk of burns!

To avoid the hazard results please follow the safety instructions below.

- The tank surface gets very hot when the device is in use! In order to avoid burns of fingers and hands do not touch hot surfaces of the device! During operation touch only handles and switches designed for such purpose.
- Also after turning the device off its surface and coffee remaining in the water tank are hot for some time, therefore leave the device for cooling down before cleaning or moving to another location.
- **Never** move hot device during work.



HOT STEAM! Risk of scalding!!

To avoid the hazard results please follow the safety instructions below.

- Never remove lid from the water tank during the brewing process. The released hot steam may cause burns of hands, arms, and face.
- During the brewing process hot steam is released from the steam release opening in the lid. Follow the warning labels on the lid and avoid contact with that area during the operation to exclude the risk of hands and arms burns.

1.3 Proper use

The operational safety of the device is assured only in case of proper use, according to the operation manual.

All technical activities like installation and maintenance must be performed by the qualified service personnel only.

The device is intended for home use or in similar places such as:

- in kitchens for store or office employees or in similar business areas;
- in agricultural farms;
- by guests of hotels, motels and other typical places of accomodation;
- in Bed and Breakfast facilities.

The coffee machine is designed only for **preparation of coffee** and **warm/hot water** with use of cold water.

The coffee machine must not be used for:

- heating or boiling of liquids containing sugar, sweeteners, lyes, or alcohols;
- storage and heating of flammable, health hazardous and easily evaporating liquids and materials, etc.



CAUTION!

Any use going beyond the intended purpose and/or any different use of the device is forbidden and is not considered as conventional.

Any claims against the manufacturer or his authorized representative as a consequence of experiencing damages resulting from unconventional use are impossible.

The operator is liable for all damages resulting from inappropriate use.

2. General information

2.1 Liability and Warrantees

All the information and instructions in this manual take into account standard safety regulations, current levels of technical engineering as well as the expertise and experience we have developed over the years.

The instruction manual was translated with all due care and attention. However, we do not accept liability for any translation errors. The German version of this instruction manual is definitive.

If the delivery consists of a special model, the actual scope of delivery may differ from the descriptions and illustrations in this manual. This is also the case for special orders or when the device has been modified in line with new technology.



CAUTION!

Read this manual carefully and thoroughly before any operation of the device, and especially before turning it on!

Manufacturer **is not liable** for any damages or faults caused by:

- violation of advice concerning operation and cleaning;
- use other than designed;
- alterations made by user;
- use of inadequate spare parts.

We reserve the right to make technical changes for purposes of developing and improving the useful properties.

2.2 Copyright protection

The instruction manual including any texts, drawings, images or other illustrations is copyright. No part of this publication may be reproduced, transmitted or used in any form or by any means without permission in writing from the manufacturer. Any person who commits any unauthorized act in relation to this publication shall be liable to claims for damages. All rights reserved.



NOTE!

The contents, texts, drawings, pictures and any other illustrations are copyright and subject to other protection rights. Any person unlawfully using this publication is liable to criminal prosecution.

2.3 Declaration of conformity



The device complies with the current standards and directives of the EU. We certify this in the EC declaration of conformity. If required we will be glad to send you the according declaration of conformity.

3. Transport, packaging and storage

3.1 Delivery check

Please check the delivery upon completeness and transport damage immediately after receipt. In case of visible damage do not accept or accept the delivery with reservation only.

Note the extent of damage on the carrier's bill of delivery. Trigger off the complaint.

Hidden damages should be reclaimed immediately after notice, as claims for damages can only be asserted within the effective period for complaints.

3.2 Packaging

Please do not throw away the covering carton of your device as it might be useful for storage purposes, when moving or, in case of damages, when the device must be sent back to a repair center. The outer and inner packing material should be removed completely from the device before installation.



NOTE!

If you liked to dispose the packing, consider the regulations applicable in your country. Supply re-usable packing materials to the recycling.

Please inspect the device upon completeness. In case any part is missing please contact our customer service center immediately.

3.3 Storage

Keep the package closed until installation and under consideration of the outside indicated positioning- and storage markings.

Packages should be stored under consideration of the following:



- do not store outdoors,
- keep it dry and dust-free,
- do not expose it to aggressive media,
- do not expose it to direct sunlight,
- avoid mechanical shocks and vibration,
- in case of longer storage (> 3 months) make sure you check the state of the packaging and the parts regularly, if required refresh or renew.

4. Technical data

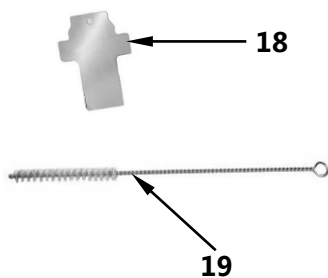
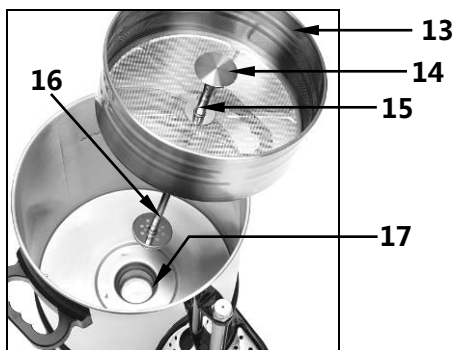

4.1 Overview of parts



Description of drawings on page 10

- | | |
|--|--|
| 1 Lid handle | 11 Fill level indicator |
| 2 Lid | 12 Steam outlet hole |
| 3 Handle of water tank | 13 Filter basket |
| 4 Water tank | 14 Water distributor for riser pipe |
| 5 Descaling indicator (red)  | 15 Riser pipe elongation |
| 6 ON/OFF switch with integrated lamp (red) | 16 Riser pipe |
| 7 Keep warm indicator (green)  | 17 Heating bowl |
| 8 Base unit | 18 Scale deposit scraper |
| 9 Drain tray | 19 Cleaning brush |
| 10 Drain tap | |

Additional equipment (not included in the delivery!)

	Round paper filter PRO II 40T + PRO II 60T (250 pieces per package)	Code-no.: A190009250
	Round paper filter PRO II 40T + PRO II 60T (1000 pieces per package)	Code-no.: A190009
	Round paper filter PRO II 100T (250 pieces per package)	Code-no.: A190011250
	Round paper filter PRO II 100T (1000 pieces per package)	Code-no.: A190011
	Quick descaler for coffee machine (30 bags 15 g each)	Code-no.: 190065

4.2 Technical specification

Name	Coffee machine		
Model:	Bartscher PRO II 40T	Bartscher PRO II 60T	Bartscher PRO II 100T
Code-no.:	A190148	A190167	A190198
Material:	Stainless steel, plastic		
Realization:	<ul style="list-style-type: none"> ▪ Round filter ▪ Fill level indicator ▪ Descaling indicator ▪ Power supply indicator ▪ Temperature maintaining function ▪ Properties: <ul style="list-style-type: none"> - The coffee machine may be used with the paper filter or without it. - Two independent heating systems for brewing and temperature maintaining. 		
Power supply:	230 V~ 50 Hz		
Power:	1.2 kW	1.2 kW	1.45 kW
Capacity:	6 litres	9 litres	13.2 litres
Brewing time	40 minutes. for 6 litres	50 minutes. for 9 litres	55 minutes. for 13.2 litres
Maximum output:	40 - 48 cups	60 - 72 cups	90 - 100 cups
Maximum brewed amount:	3 litres (20 cups)	4.5 litres (30 cups)	6 litres (40 cups)
Dimensions (mm):	W 310 D 320 H 480	W 310 D 320 H 540	W 350 D 370 H 575
Weight:	3.178 kg	3.8 kg	4.6 kg
Includes:	1 cleaning scraper, 2 water distributors (6 mm and 12 mm) for the riser pipe elongation, 1 spare seal for drain tap and 1 for riser pipe		

Subject to technical changes and alterations!

5. Installation and operation

5.1 Installation

- Unpack the device and remove all package materials according to the valid environment protection regulations.



CAUTION!

Never remove the nameplate and warning signs from the device.

- Put the device on an even, stable, dry and waterproof surface which is resistant to high temperature.
- **Never** place the device on an inflammable surface.
- **Never** put the device in a moist or wet area.
- **Never** place the device at the edge of a table to avoid tilting or falling.
- Do not place the device near open flame, electric heaters or other heat source.
- Place the device so that the plug is easily accessible so as to quickly disconnect the device if the need arises.

Connection



DANGER! Electric shock hazard!

The device can cause injuries due to improper installation! Before installation and connecting the local power grid specification should be compared with that of the device (see rating plate). Connect the device only in case of compliance!

Connect the device only to properly installed single socket with protective terminal.

- The electrical circuit in the socket must be secured to 16A. Only connect the device directly to the wall socket; do not use any extension cords or power strips.

5.2 Operation

Prepare the device

- Remove the lid and remove the filter basket and riser pipe from the water tank.
- Before the first use wash the device according to instructions in **section 6 “Cleaning and descaling”**.



CAUTION!

Never immerse the device base in water!

Coffee preparation

- Fill the water tank with **cold** water (the necessary amount of water may be read from the filling indicator level). **Never use warm water for coffee preparation!**
- Pay attention to the **minimum required amount for brewing** during the coffee preparation. It is:

for **A190148** → **20 cups** → 3.0 litres

for **A190167** → **30 cups** → 4.5 litres

for **A190198** → **40 cups** → 6.0 litres



CAUTION!

Do not activate the device when the water tank is empty.

Do not fill the coffee machine with water above the maximum filling level!

- To assemble the filter basket group put the riser pipe into the filter basket opening and place both elements in the tank. Make sure that the riser pipe is placed in the centre of the heating bowl in the tank bottom.



NOTE!

The optimum filter from the high-grade stainless steel allows for coffee preparation either with the paper filter or without it.

We recommend suitable round paper filter **BARTSCHER A190009** or **A190009250** for models **Bartscher PRO II 40T (A190148)** + **Bartscher PRO II 60T (A190167)** and round paper filter **A190011** or **A190011250** for model **Bartscher PRO II 100T (A190198)**.

- Depending on preferences it is possible to place the suitable paper filter to the filter basket or to prepare coffee without it.
- Pour coarsely ground coffee to the filter basket (approx. 5 g per cup).



NOTE!

The recommended coffee amount may be higher or lower, depending on the preferences.



- Select the water distributor according to the amount of coffee. Turn it slightly when placing onto the riser pipe elongation in the filter basket to secure its attachment. For the optimal water distribution, use the 12 mm water distributor for half to maximum volume of boiling water and the 6 mm water distributor in other cases.
- Put the lid on the coffee machine and lock it with the bayonet lock.
- Activate the coffee machine by switching the **ON/OFF** switch to position “**I**”. During the brewing process the red operation control light in the switch will come on.



HOT STEAM! Risk of scalding!

Never touch rotating parts of the device during its operation. The released hot steam may cause burns of hands, arms, and face.

During the brewing process hot steam is released from the steam release openings in the lid, avoid contact with that area.

- After the brewing process end the green control light of temperature maintaining comes on **SSS**, then power is automatically reduced and coffee is kept in the serving temperature until the **ON/OFF** switch is switched to position “**O**” or the plug is removed from the socket.



NOTE!

After the brewing process remove the filter basket with the coffee grounds from the water tank. It allows to keep good taste of coffee.



HOT SURFACE! Risk of burns!

The filter basket, the riser pipe, and the coffee grounds are very hot after the brewing process. Use the protective gloves to remove them!

- ❖ The device is equipped with **overheating/dry operation protection**. In case of accidental start-up without water or with its insufficient amount the protection will be activated and the device will be automatically turned off.



CAUTION!

When the overheating protection is activated and the device turns off, disconnect it from the socket (pull the plug!) and leave for cooling down.

Remove the base and press the RESET button on the bottom of the device.

The coffee machine is ready for the operation again.

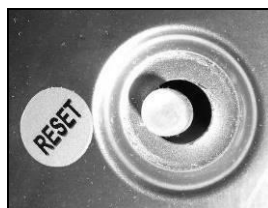

Coffee serving

- Place the cup or glass under the drain tap, press the tap slightly down and hold until the cup is filled with required amount of coffee.
- Release the drain tap, which closes automatically.
- In order to obtain full flow press the tap lever fully down.



NOTE!

The drain tap is located a little higher, therefore the coffee grounds remain on the water tank bottom and do not enter the served coffee.

- When the device is placed in normal position and the coffee does not flow, remove the plug and fill the device with fresh water after cooling down, when required.

Instructions and advices

- Before brewing another coffee batch rinse the coffee machine thoroughly with cold water to cool it down.
- Any drops arising from removing the filter basket and the wet coffee grounds should be collected with use of coffee machine lid.

- The coffee machine allows also for water heating. Fill clean tank with cold water, install the riser pipe and clean filter basket. Turn the device on as for brewing coffee.
- Switch the device to “O” as soon as the brewing cycle is ended.
- Remove the plug when there are less than 4 cups in the water tank.



NOTE!

When the coffee machine is no longer used, remove the riser pipe, otherwise it may become jammed in the heating bowl.

6. Cleaning and descaling



WARNING!

Before cleaning switch the device off with use of ON/OFF switch and disconnect it from the power supply (pull the plug!). Let the device to cool down.

Never clean the device with use of pressurized water jet!

Make sure that no water gets into the device.



CAUTION!

Never wash the device or its elements in the dishwasher.

Do not use any sharp objects or abrasive cleaning agents for surface cleaning.

Daily cleaning

- Clean the device thoroughly before the first and all successive uses.
- Clean the filter basket, the riser pipe, and the lid with warm water and gentle **commercially available cleaning agent for professional coffee machines**. Follow the manufacturer's instructions.
- All washed parts should be rinsed with clean water to remove the washing agents residuals.
- The water tank should be kept free from any deposits and coffee residuals. It may be easily cleaned inside with use of gentle cleaning agent and dishcloth.

- To clean the drain tap after use pour low amount of warm water into the coffee machine and drain it through the tap.
- Before cleaning remove the base and the drain tray, pulling the water tank up.
- Wash the removed parts in warm water with gentle cleaning agent. Rinse in clean water.
- Wipe the water tank exterior with soft, moist cloth.
- Finally dry all cleaned parts and surfaces with soft cloth.



Weekly cleaning

Fill level indicator

- Clean the glass pipe of the fill level indicator with included brush.
- First unscrew the indicator cover (a).
- Then remove the glass pipe (b).
- Remove the lower seal (b) from the glass pipe and clean it with included brush.
- Finally reinstall the seal on the lower end of the glass pipe and put the pipe in the level indicator holder.
- Tighten the cover (a) on the fill level indicator.

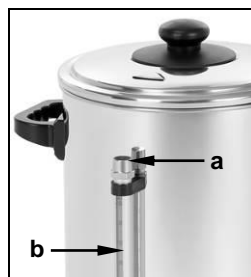

CAUTION!

Check if the glass pipe is correctly positioned in the holder.

Drain tap

- If the device is used daily, it is necessary to thoroughly clean the tap mechanism once weekly, or less frequently in case of less intensive use.
- To clean the drain tap unscrew the upper part with holder (c). Clean the tap and connection between the tap and the device with small bottle brush. Rinse the removed part of the drain tap and reinstall in the device.



Heating bowl

- The heating bowl of the device must be thoroughly cleaned every week, especially in case of daily use of the device.
- The accessories supplied with the device include scraper for removing scale deposits from the heating bowl in the water tank bottom.



NOTE!

Always use only included scraper for removing the scale deposits!

- Put the steel wool cloth soaked in soap or thin dishcloth on the heating bowl.
- Put the narrow end of the scraper into the heating bowl.
- The heating bowl is cleaned by rotating the scraper multiple times. When it is clean, the metal shines.
- After cleaning rinse the water tank thoroughly to remove all residuals of soap and cleaning agents.

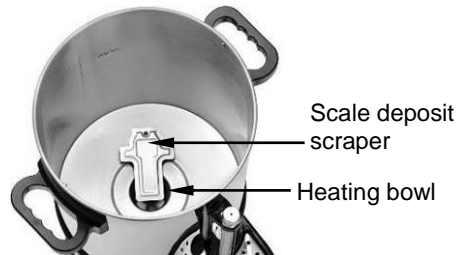

Descaling



CAUTION!

The coffee machine should be regularly descaled to extend its life span and assure good quality of coffee.

The complaints will not be taken into consideration when the device is not periodically descaled –according to the instructions–.

Such claims are not covered by the warranty!

- The device is equipped with **red descaling indicator** . Depending on the hardness of used water the indicator may be activated after some brewing cycles, which indicates that the device must be descaled. At the same time the overheating protection is activated and the device is turned off.
- We recommend **descaling of the device** with our tested coffee machine descaler “**Quick descaler for coffee machine**”:

Code-no.: 190065; packing unit: 30 bags per 15 g).



CAUTION!

Do not leave the device unattended during descaling!

Use the protective gloves and goggles during descaling to protect yourself from the descaling solution splashes.

- **Descaling** of the device should be realized according to the following instructions:
 - Dissolve the content of the **bag** (15 g) in approximately **5 litres** of water.
 - Slide the riser pipe through the filter basket centre and place it in the water tank. Make sure that the riser pipe has been carefully inserted in the heating bowl.
 - Pour the descaling solution into the water tank of the coffee machine. Put the lid on the water tank and activate the device.
 - Perform the brewing cycle and leave the coffee machine on for next 15 minutes.
 - Then turn the device off and drain the descaling solution through the drain tap to the suitable container.
 - After descaling repeat the brewing cycle **at least three times** with use of clean water to remove all residuals of the descaling solution.
 - Pour some fresh water into the tank and drain to the suitable container through the drain tap to rinse it.
 - Rinse the water tank, the riser pipe, the filter basket, and the lid thoroughly with clean water.
 - Finally dry all cleaned parts and surfaces with soft cloth.
- After descaling the coffee maker must be turned on **only** after pressing the **RESET** button in the base. The red descaling indicator will not come on after the device activation.
- The coffee machine is ready for the operation again.
- Wash your hands thoroughly after descaling.

Storage of the device

- If the device is not used for any lengthy period of time, clean it according to the aforementioned description and store it in dry, clean place protected against cold, sun and children. Do not place any heavy objects on the device.

7. Possible Malfunctions

In case of malfunction, disconnect the device from its power source. Before contacting the service or sales agent, verify - based on the table below - whether it is possible to eliminate disruption in operation.

Problem	Cause	Solution
The device is turned on, but the red indicator light does not turn on.	<ul style="list-style-type: none"> The power plug is not properly inserted into the socket Disconnected fuse Damaged indicator light Damaged switch 	<ul style="list-style-type: none"> Properly insert the plug into the socket Check the fuse Check the device in another socket Contact a salesperson
Red descaling indicator is on during the operation.	<ul style="list-style-type: none"> The device is scaled 	<ul style="list-style-type: none"> Remove the plug. Leave the device until cooling down, then descale it according to section 6 "Cleaning and descaling"
The device is turned on, the ON/OFF switch indicator is on, but the device is not heating.	<ul style="list-style-type: none"> Damaged heating element Damaged thermostat 	<ul style="list-style-type: none"> Contact a salesperson Contact a salesperson
The device turns off.	<ul style="list-style-type: none"> Damaged thermostat The device is scaled 	<ul style="list-style-type: none"> Remove the power plug and leave the device to cool. Remove the base and press the RESET button on the bottom of the device. Bear in mind the necessary quantity of water in the device. Descale the device according to section 6 „Cleaning and descaling“
The green indicator light does not turn on.	<ul style="list-style-type: none"> The brewing / heating process is not completed yet Damaged indicator light Damaged thermostat 	<ul style="list-style-type: none"> Wait until the brewing / heating process will be completed Contact a salesperson Contact a salesperson
The fuse blows immediately after turning on.	<ul style="list-style-type: none"> Electrical short circuit 	<ul style="list-style-type: none"> Contact a salesperson

If you cannot remove the malfunctions:

- do not open the body,
- notify the customer service point or contact the sales agent, while providing the following information:
 - type of malfunction;
 - article and serial number (rating plate at the rear of the device).

8. Waste disposal

Discarding old devices

At the end of its service life the discarded device has to be disposed in accordance with the national regulations. It is advisable to contact a company which is specialized in waste disposal, or just contact the local disposal service in your community.



WARNING!

To exclude any abuse and the dangers involved make the waste device unfit for use before disposal. For that purpose disconnect device from mains supply and remove mains connection cable from the device.



CAUTION!



For the disposal of the device please consider and act according to the national and local rules and regulations.

Bartscher GmbH
Franz-Kleine-Str. 28
33154 Salzkotten
Germany

phone: +49 (0) 5258 971-0
fax: +49 (0) 5258 971-120